

1X1840I

Rev.2

DESCRIZIONE Vasca quadra raggio "15" incasso e filo da 18x40
DESCRIPTION 18x40 cm built-in and flush square bowl with radius "15"

PESO LORDO 3.8 kg
GROSS WEIGHT

DIMENSIONI IMBALLO 260x495x270 mm
PACKAGING DIMENSIONS

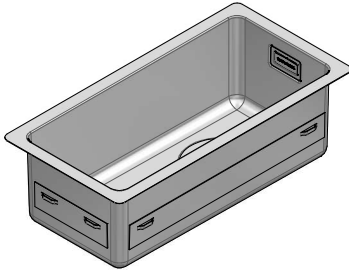

! E' NECESSARIO FARE UNO SCANSO NEL TOP IN CORRISPONDENZA DEL TROPPOPIENO
YOU SHOULD MAKE A SLOT IN THE TOP WHERE THE OVERFLOW IS INSTALLED

- Acciaio inox AISI 304 di spessore elevato (AISI 304 extra thick stainless steel)
- Dimensione vasca: 18x40x14 h (Bowl dimensions: 18x40x14 h cm bowl)
- Dotazioni: pilettona 3"1/2, troppo-pieno con scarico perimetrale (Equipment: 3.5" basket strainer waste perimeter overflow) (A)
- Base per inserimento vasca: 30 cm (Base unit for bowl: 30 cm)
- Incasso: 20x42 cm + intaglio per troppo-pieno (Built-in: 20x42 cm cut out + notch for overflow)
- Filotop: 22,3x44,3 cm (Flush: 22,3x44,3 cm)

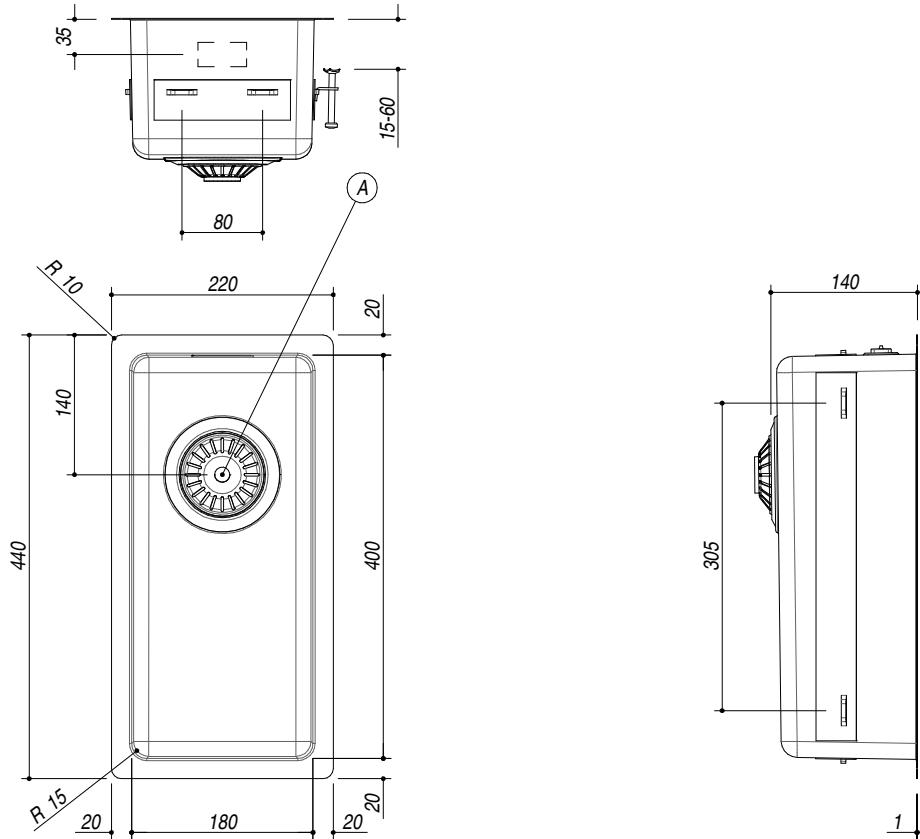

SCALA DISEGNO 1:7.5
DRAWING SCALE

TUTTE LE MISURE IN mm
ALL MEASURES IN mm

TOLLERANZA LINEARE: ± 0.5 mm
LINEAR TOLERANCE

TOLLERANZA ANGOLARE: ± 0.2 °
ANGULAR TOLERANCE

FORATURA PER INSTALLAZIONE AD INCASSO
BUILT-IN CUTOUT FOR TOP

*** SCANSO NEL TOP PER IL TROPPOPIENO**
*** SLOT IN THE TOP FOR THE OVERFLOW**

FORATURA PER INSTALLAZIONE A FILO
FLUSH CUTOUT FOR TOP

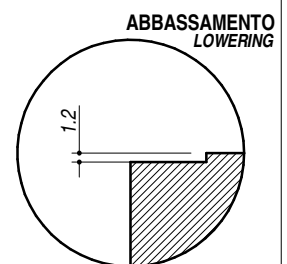
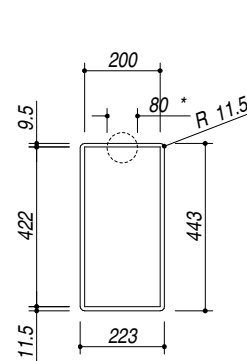
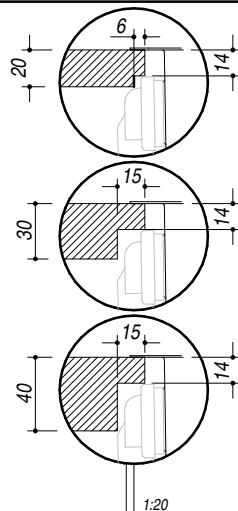
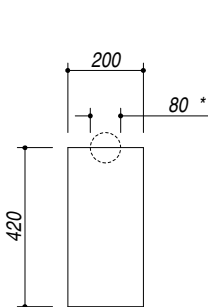

1:20

1:20