

1QR50I

DESCRIZIONE Vasca quadra raggio "12" incasso e filo da 50x40
DESCRIPTION 50x40 cm built-in and flush square bowl with radius "12"

PESO LORDO 8.4kg
GROSS WEIGHT

DIMENSIONI IMBALLO 595x495x270 mm
PACKAGING DIMENSIONS

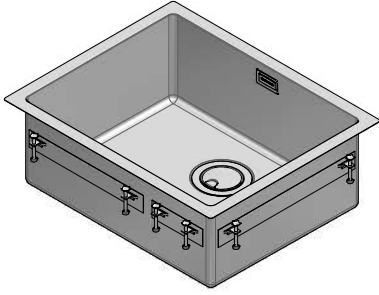

- Acciaio inox AISI 304 di spessore elevato (AISI 304 extra thick stainless steel)
- Dimensione vasca: 50x40x20 h cm (50x40x20 h cm bowl)
- Dotazioni: (A) pilettone 3"1/2 acciaio inox, copripilettone in acciaio inox, troppo-pieno con scarico perimetrale (Equipment: 3"1/2 stainless steel basket strainer waste, stainless steel drain cover, perimeter overflow)
- Base inserimento vasca: 60 cm (60 cm base unit for bowl)
- Incasso: 53,5x43,7 cm (53,5x43,7 cm cut-out)
- Filotop: 55,8x45,8 cm (Flush: 55,8x45,8 cm)

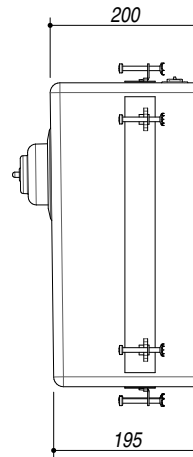
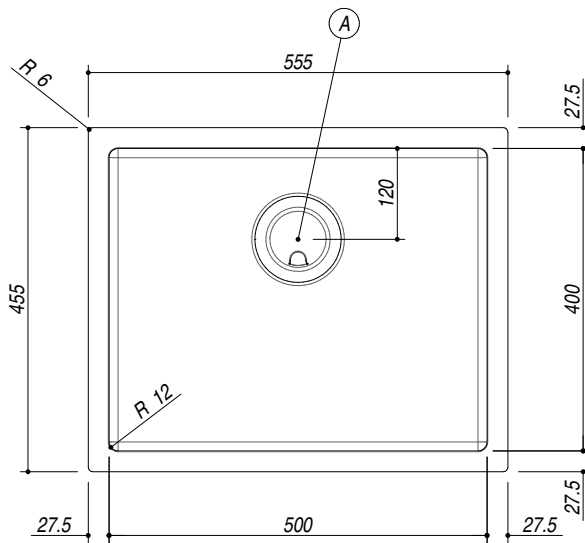
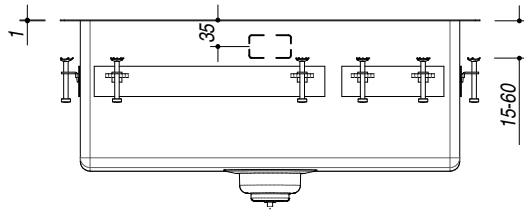

SCALA DISEGNO 1:10
DRAWING SCALE

TUTTE LE MISURE IN mm
ALL MEASURES IN mm

TOLLERANZA LINEARE: ± 0.5 mm
LINEAR TOLLERANCE

TOLLERANZA ANGOLARE: ± 0.2 °
ANGULAR TOLLERANCE

FORATURA PER INSTALLAZIONE AD INCASSO
BUILT-IN CUTOUT FOR TOP

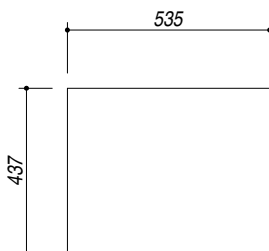

1:20

FORATURA PER INSTALLAZIONE A FILO
FLUSH CUTOUT FOR TOP

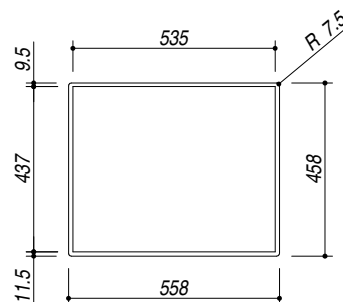

1:20

ABBASSAMENTO
LOWERING

